



# ceramic sinks

**A timeless classic.** With all of the simple, elegant quality of a bygone era, yet equally at home in the most contemporary of settings – it's no wonder ceramic sinks are enjoying such a huge renaissance.



# farmhouse sinks

With generous proportions and strong character, farmhouse style sinks are for those who want a modern interpretation of the way sinks used to be.



## A touch of class

Classic and elegant, this Victorian sink style is characterised by a striking front face which sits proudly on show. It looks superb in a traditional setting, but is equally at home as a design piece within a contemporary kitchen. Made lovingly by hand using traditional methods and materials, our ceramic sinks are fired in intense heat to ensure a non-porous, scratch, heat and chemical resistant finish.

For the majority of farmhouse sinks, the tap is mounted neatly into the worktop itself, which gives you the freedom to choose larger, more sculptural tap designs. As they are fitted beneath the worktop, these sinks can be used with granite, solid surface or wooden worktops.



### Epsom farmhouse sink

This sink fits the full depth of a conventional sized worktop, with the tap fitted into the sink. Both practical and stylish, this one and a half bowl variation of the farmhouse sink is designed to make an impact.

*Note: Each sink is hand finished, so no two sinks are ever alike – sizes may vary by plus-or-minus 2%. Therefore, we recommend that you measure the actual sink before fitting.*

## Ceramic drainer option



Subtle and sweet, this square ceramic drainer has been specifically designed to complement farmhouse style sinks. It sits neatly on top of the worktop next to your sink and when not in use, can be simply stored away.

CPDRAINER

W 460mm

### General features

White

Freestanding to sit on countertop

Fluted design

### Dimensions

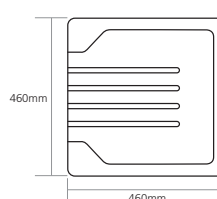

Width 460mm

Depth 460mm

Height 50mm

Dimensions may vary plus or minus 2%



Belfast 600 – *Sit-on*  
CPBS2

W 595mm

**General features**

- White
- Reversible
- No tap facility
- 65mm waste outlet
- Weir overflow

**Plumbing options**

- Stainless steel waste CAP/PW/SS2
- Chrome waste CAP/SL/CH
- Brass waste CAP/SL/GO
- Plumbing kit CPK1

**Accessory options**



Wooden chopping board  
CBB3040B

**Dimensions**

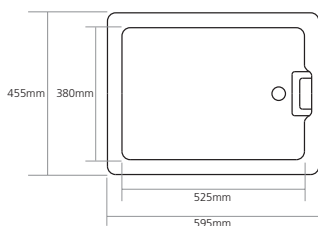

Bowl depth 215mm  
Overall sink depth 250mm  
Min. base unit 600mm  
Dimensions may vary plus or minus 2%



Belfast 915 – *Sit-on*  
CPBS36

W 915mm

**General features**

- White
- Reversible
- No tap facility
- 65mm waste outlet
- Weir overflow

**Plumbing options**

- Stainless steel waste CAP/PW/SS2
- Chrome waste CAP/SL/CH
- Brass waste CAP/SL/GO
- Plumbing kit CPK1

**Accessory options**



Wooden chopping board  
CBB3040B

**Dimensions**

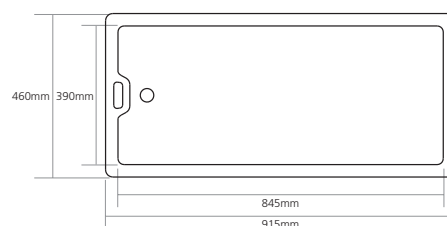

Bowl depth 229mm  
Overall sink depth 255mm  
Min. base unit 1000mm  
Dimensions may vary plus or minus 2%



Butler 600 – *Sit-on*  
CPBS600

W 595mm



Butler 755 – *Sit-on*  
CPWDS750

W 755mm

**General features**

- White
- No tap facility
- 90mm waste outlet for a basket strainer waste
- Suitable for a waste disposer
- Includes chrome overflow
- Waste BSW/OF/SS to be ordered separately

**Plumbing options**

- Stainless steel waste BSW/OF/SS
- Plumbing kit CPK1

**Accessory options**



Wooden chopping board  
CBB3040B

**General features**

- White
- Reversible
- No tap facility
- 90mm waste outlet for a basket strainer waste
- Suitable for a waste disposer

**Plumbing options**

- Stainless steel waste BSW/OF/SS
- Chrome waste BSW/CH2
- Plumbing kit CPK1

**Accessory options**



Wooden chopping board  
CBB3040B

**Dimensions**

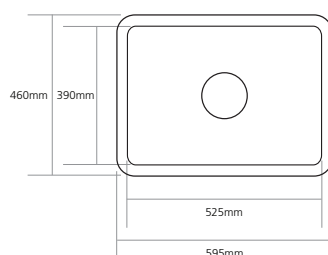

Bowl depth 220mm  
Overall sink depth 255mm  
Min. base unit 600mm  
Dimensions may vary plus or minus 2%

**Dimensions**

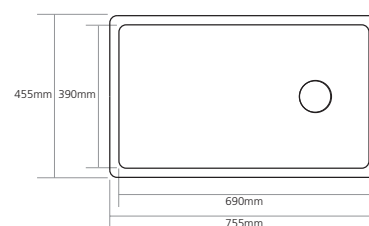

Bowl depth 220mm  
Overall sink depth 255mm  
Min. base unit 800mm  
Dimensions may vary plus or minus 2%



Butler 800 – *Sit-on*  
CPBS800

W 795mm



Yorkshire – *Sit-on*  
YORK

W 595mm

**General features**

- White
- Reversible
- No tap facility
- 90mm waste outlet for a basket strainer waste
- Suitable for a waste disposer
- Includes chrome overflow
- Waste BSW/OF/SS to be ordered separately

**Plumbing options**

- Stainless steel waste BSW/OF/SS
- Plumbing kit CPK1

**Accessory options**



Wooden chopping board  
CBB3040B

**General features**

- White
- No tap facility
- 90mm waste outlet for a basket strainer waste
- Suitable for a waste disposer

**Plumbing options**

- Stainless steel waste and overflow CPK15
- Chrome waste and overflow CPK19
- Plumbing kit CPK1

**Accessory options**



Wooden chopping board  
CBB3040B

**Dimensions**

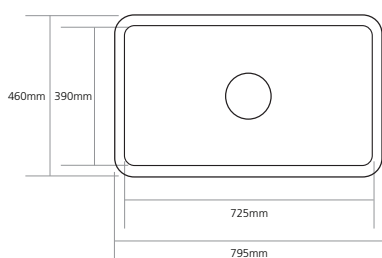

Bowl depth 229mm  
Overall sink depth 255mm  
Min. base unit 800mm  
Dimensions may vary plus or minus 2%

**Dimensions**

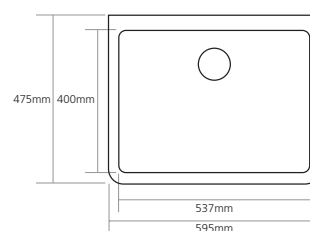

Bowl depth 195mm  
Overall sink depth 225mm  
Min. base unit 600mm  
Dimensions may vary plus or minus 2%



Pemberley – *Sit-on*  
PEMBERLEY

W 597mm

**General features**

- White
- No tap facility
- 90mm waste outlet for a basket strainer waste
- Suitable for a waste disposer
- Includes chrome overflow
- Waste BSW/OF/SS to be ordered separately

**Plumbing options**

- Stainless steel waste BSW/OF/SS
- Plumbing kit CPK1

**Accessory options**



Wooden chopping board  
CBB3040B



Epsom – *Sit-on*  
EPSOM

W 900mm

**General features**

- White
- 3 Semi-punched tap holes
- 2 90mm waste outlets for basket strainer wastes
- Suitable for a waste disposer

**Plumbing options**

- Stainless steel waste kit BSW/OF/SS (x2)
- Chrome waste kit BSW/CH2 (x2)
- Plumbing kit CPK2

**Accessory options**



Wooden chopping board  
CBB3040B

**Dimensions**

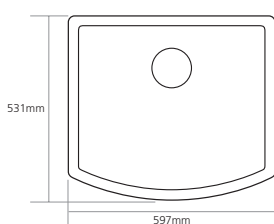

Bowl depth 190mm  
Overall sink depth 220mm  
Min. base unit 600mm  
Dimensions may vary plus or minus 2%

**Dimensions**

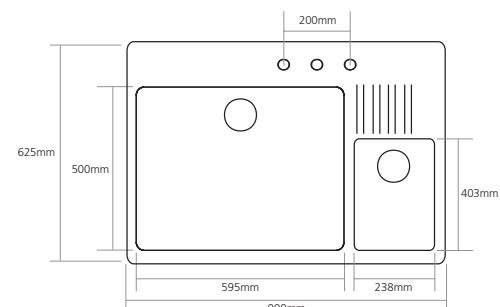

Main bowl depth 155mm  
Small bowl depth 155mm  
Overall sink depth 200mm  
Min. base unit 900mm  
Dimensions may vary plus or minus 2%





Sandown – *Sit-on*  
SANDOWN

W 800mm

**General features**

- White
- 1 Semi-punched tap hole
- 2 90mm waste outlets for basket strainer wastes
- Suitable for a waste disposer

**Plumbing options**

- Stainless steel waste kit CPK8
- Chrome waste BSW/CH2 (x2)
- Antique gold waste kit CPK22
- Plumbing kit for stainless steel or gold wastes CPK1
- Plumbing kit for chrome or brushed chrome wastes CPK2

**Accessory options**



Wooden chopping board  
CBB3040B

**Dimensions**

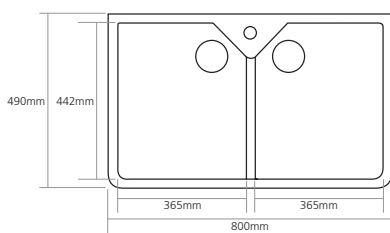

Depth of bowls 190mm  
Overall sink depth 220mm  
Min. base unit 800mm  
Dimensions may vary plus or minus 2%



Kempton – *Sit-on*  
KEMPTON

W 795mm

**General features**

- White
- No tap facility
- 2 90mm waste outlets for basket strainer wastes
- Suitable for a waste disposer
- Includes chrome overflow
- Wastes 2 x BSW/OF/SS to be ordered separately

**Plumbing options**

- Stainless steel waste BSW/OF/SS (x2)
- Plumbing kit CPK2

**Accessory options**



Wooden chopping board  
CBB3040B

**Dimensions**

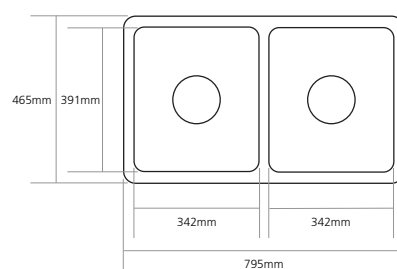

Depth of bowls 191mm  
Overall sink depth 229mm  
Min. base unit 800mm  
Dimensions may vary plus or minus 2%

# inset sinks



Inset ceramic sinks with their elegant lip and smooth lines, blend subtly into the worktop surface. Smart, sophisticated and extremely robust, this very versatile style of sink will look great in any kitchen.

If you have your heart set on a ceramic sink, but don't want to limit your worktop options – an inset style is the answer. From traditional shapes with beautifully crafted drainer patterns, to sleek, linear models, they come in an array of designs to suit any decor. Inset sinks feature a smooth lip that sits on top of the worktop, providing a neat and tidy finish.

The tap is then mounted on top of the sink itself. It is this fitting method which makes these sinks so versatile, allowing you to combine them with an array of worktops including granite, wooden or solid surface. It is also the best choice for those who prefer laminate worktops.



### Designer draining

Most inset sinks feature a built-in drainer. Although drainers have a functional purpose, the design of the drainer pattern can have a dramatic impact on the overall look of the sink. If you're after a flat, modern drainer, our Avalon sinks will fit the bill, or if you prefer something softer, try our romantic Winchester range.



*Note: Each sink is hand finished, so no two sinks are ever alike – sizes may vary by plus-or-minus 2%. Therefore, we recommend that you measure the actual sink before fitting.*



Ashford 100 – Inset with drainer  
ASH1W

W 920mm

**General features**

- White
- Reversible
- 2 Semi-punched tap holes
- 90mm waste outlet for a basket strainer waste
- Suitable for a waste disposer

**Accessory options**



Wooden chopping board  
CBB3040B



Chrome basket  
CMBB18CH

**Plumbing options**

- Stainless steel waste and overflow CPK5
- Chrome waste and overflow CPK19
- Plumbing kit for stainless steel waste CPK1
- Plumbing kit for gold waste CPK1/2

**Dimensions**

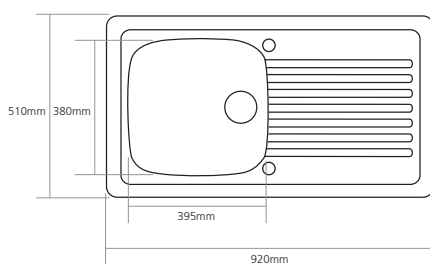

Bowl depth 180mm  
Overall sink depth 210mm  
Min. base unit 500mm  
Cut out size 880 x 480mm  
Dimensions may vary plus or minus 2%



Ashford 150 – Inset with drainer  
ASH15W

W 1000mm

**General features**

- White
- Reversible
- Overflow will be at front if reversed
- 4 Semi-punched tap holes
- 2 90mm waste outlets for basket strainer wastes
- Suitable for a waste disposer

**Accessory options**



Wooden chopping board  
CBB3040B



Chrome basket  
CMBB13CH

**Plumbing options**

- Stainless steel waste, bowl connection kit and overflow CPK8
- Antique gold waste and overflow CPK22
- Plumbing kit CPK1



Chrome small bowl basket  
CSB1CH

**Dimensions**

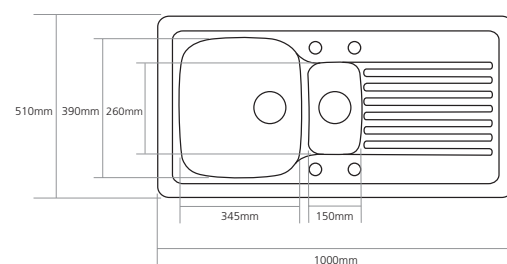

Main bowl depth 180mm  
Small bowl depth 110mm  
Overall sink depth 210mm  
Min. base unit 600mm  
Cut out size 970 x 470mm  
Dimensions may vary plus or minus 2%



Avalon 100 – Inset with drainer  
AVA1W

W 1000mm



Avalon 150 – Inset with drainer  
AVA15W

W 1000mm

**General features**

- White or black
- Left or right handed drainer
- 2 Semi-punched tap holes, 1 punched (centre)
- 90mm waste outlet for a basket strainer waste
- Suitable for a waste disposer

**Model codes**

- Left handed drainer  
AVA1W/L or AVA1B/L
- Right handed drainer  
AVA1W/R or AVA1B/R

**Plumbing options**

- Stainless steel waste and overflow CPK5
- Antique gold waste and overflow CPK16
- Plumbing kit CPK1



**Colour codes**  
White – AVA1W  
(shown above)  
Black – AVA1B

**Dimensions**

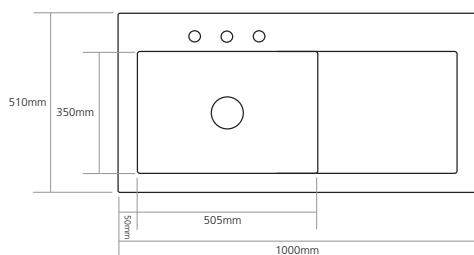

Bowl depth 190mm  
Overall sink depth 220mm  
Min. base unit 600mm  
Cut out size 970 x 480mm  
Dimensions may vary plus or minus 2%

**General features**

- White or black
- Left or right handed drainer
- 2 Semi-punched tap holes, 1 punched (centre)
- 2 90mm waste outlets for basket strainer wastes
- Suitable for a waste disposer

**Model codes**

- Left handed drainer  
AVA15W/L or AVA15B/L
- Right handed drainer  
AVA15W/R or AVA15B/R

**Plumbing options**

- Stainless steel waste, overflow and bowl connection kit CPK8
- Antique gold waste and overflow CPK22
- Plumbing kit CPK1



**Colour codes**  
White – AVA15W  
(shown above)  
Black – AVA15B

**Dimensions**

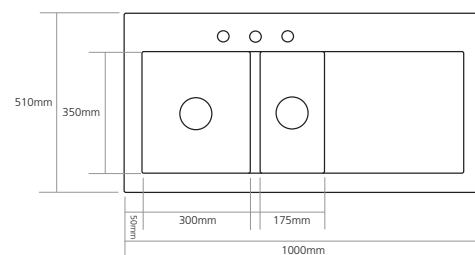

Main bowl depth 190mm  
Small bowl depth 135mm  
Overall sink depth 220mm  
Min. base unit 600mm  
Cut out size 970 x 480mm  
Dimensions may vary plus or minus 2%



Winchester 100 – *Inset with drainer*  
WIN1W W 1010mm

**General features**

- White
- Reversible
- Overflow will be at front if right hand drainer
- 2 Semi-punched tap holes
- 90mm waste outlet for a basket strainer waste
- Suitable for a waste disposer

**Accessory options**



Wooden chopping board  
CBB3040B

Chrome basket  
CMBB11CH

**Plumbing options**

- Stainless steel waste and overflow CPK15
- Chrome waste and overflow CPK19
- Plumbing kit CPK1



Winchester 150 – *Inset with drainer*  
WIN15 W 1020mm

**General features**

- White or ivory
- Reversible
- 2 Semi-punched tap holes
- Main bowl 90mm waste outlet for a basket strainer waste
- Suitable for a waste disposer
- Small bowl 60mm waste outlet

**Accessory options**

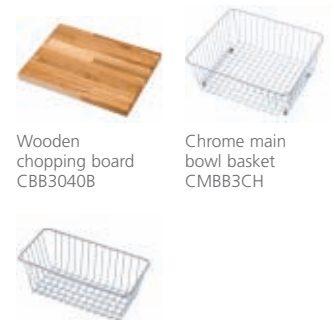

Wooden chopping board  
CBB3040B

Chrome main bowl basket  
CMBB3CH

Chrome small bowl basket  
CSB3CH

**Plumbing options**

- Stainless steel waste and bowl connection kit CPK4
- Antique gold waste and bowl connection kit CPK17
- Plumbing kit CPK1



**Model codes**

- White – WIN15W (shown above)
- Ivory – WIN15IV

**Dimensions**

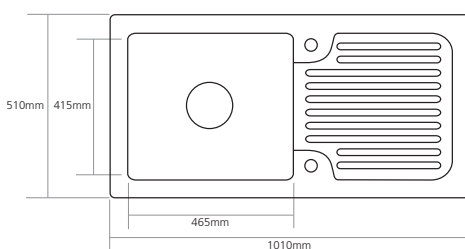

Bowl depth 200mm  
Overall sink depth 225mm  
Min. base unit 800mm  
Cut out size 978 x 496mm  
Dimensions may vary plus or minus 2%

**Dimensions**

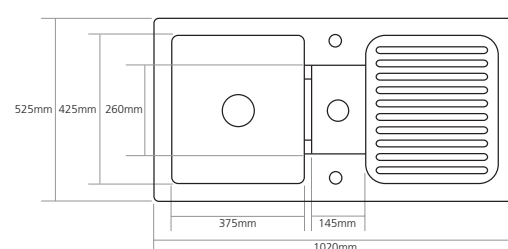

Main bowl depth 190mm  
Small bowl depth 120mm  
Overall sink depth 225mm  
Min. base unit 800mm  
Cut out size 978 x 496mm  
Dimensions may vary plus or minus 2%



Salisbury – Inset with drainer  
6761-00-01

W 920mm

**General features**

- White
- Reversible
- 2 Semi-punched tap holes
- 60mm waste outlet

**Plumbing options**

- Chrome waste and overflow kit 8212-00-61
- Plumbing kit CPK1

**Accessory options**



Wooden chopping board  
CBB3040B

Chrome basket  
CMBB13CH

**Dimensions**

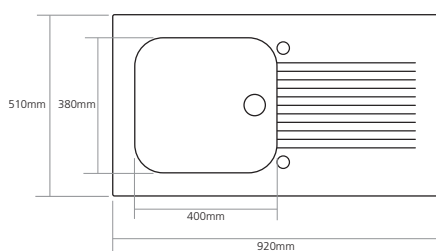

Bowl depth 175mm  
Overall sink depth 210mm  
Min. base unit 600mm  
Cut out size 875 x 460mm  
Dimensions may vary plus or minus 2%



Colorado – Inset with drainer  
CO150

W 1010mm

**General features**

- White
- Reversible
- 2 Semi-punched tap holes
- 2 90mm waste outlets for basket strainer wastes
- Suitable for waste disposer

**Plumbing options**

- Stainless steel waste and bowl connection kit CPK8
- Plumbing kit CPK1

**Accessory options**

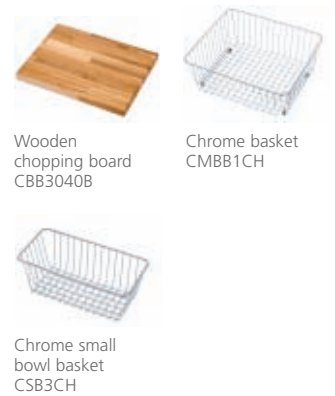

Wooden chopping board  
CBB3040B

Chrome basket  
CMBB1CH

Chrome small bowl basket  
CSB3CH

**Dimensions**

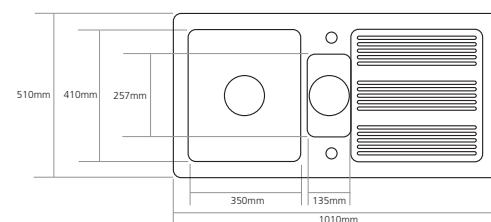

Main bowl depth 220mm  
Small bowl depth 125mm  
Overall sink depth 240mm  
Min. base unit 600mm  
Cut out size 970 x 480mm  
Dimensions may vary plus or minus 2%



Sunbury – Inset without drainer  
SUNBURY

W 965mm

**General features**

- White
- Not reversible
- 1 Punched tap hole
- 2 90mm waste outlets for basket strainer wastes
- Suitable for a waste disposer

**Accessory options**



Wooden chopping board  
CBB3040B

**Plumbing options**

- Stainless steel waste and bowl connection kit CPK8
- Chrome waste BSW/CH2 (x2)
- Plumbing kit CPK2

**Dimensions**

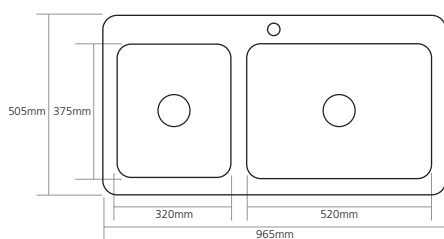

Bowl depth 200mm  
Overall sink depth 220mm  
Min. base unit 1000mm  
Cut out size 944 x 482mm  
Corner radius 25mm  
Dimensions may vary plus or minus 2%



Paladin – Inset or undermount without drainer  
PAL150

W 548mm

**General features**

- White
- Not reversible
- No tap facility
- 2 90mm waste outlets for basket strainer wastes
- Suitable for a waste disposer

**Accessory options**



Wooden chopping board  
CBB3040B

**Plumbing options**

- Stainless steel waste and bowl connection kit CPK8
- Plumbing kit CPK1

**Dimensions**

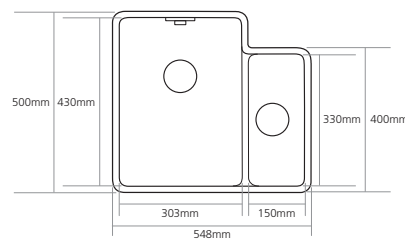

Bowl depth 200mm  
Overall sink depth 225mm  
Min. base unit 600mm  
Use template for cut-out shape see [www.caple.co.uk](http://www.caple.co.uk) for template  
Dimensions may vary plus or minus 2%



individual bowls



The elegant beauty of ceramic, combined with the freedom to create your own unique style is what makes this range of individual bowls such an attractive choice.

Practical and hard-wearing, our individual ceramic bowls are manufactured to the highest standards, ensuring that each sink is non-porous, scratch, heat and chemical proof. Our beautifully proportioned bowl depths are also ideal for accommodating a host of essential daily tasks.

Individual bowls provide complete design flexibility, enabling you to select the size, shape and number of bowls to suit

your specific needs. Another benefit of this sink style is that the tap is set into the worktop, allowing you to experiment with some of our larger, more prominent tap designs.

For a classic look, try our traditional round bowl or for something that exudes contemporary chic, combine a single sink with a stainless steel tap.

#### Versatile bowls

Both the Berkshire and Hampshire bowls are extremely versatile. They can be inset with the lip positioned above the worktop, or undermounted to fit beneath it. These sinks can be also used in combination or individually, depending on the space available – so let your creativity flow!

*Note: Each sink is hand finished, so no two sinks are ever alike – sizes may vary by plus-or-minus 2%. Therefore, we recommend that you measure the actual sink before fitting.*





Hampshire – *Inset or undermounted*  
HAMPSHIRE

W 250mm

**General features**

- White
- No tap facility
- 90mm waste outlet for a basket strainer waste
- Suitable for a waste disposer

**Plumbing options**

- Stainless steel waste and overflow CPK15
- Chrome waste and overflow CPK19
- Plumbing kit CPK1

**Fitting options**



Inset Undermounted

**Accessory options**



Wooden chopping board  
CBB3040B

**Dimensions**

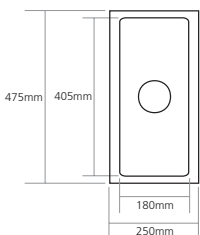

Bowl depth 130mm  
Overall sink depth 155mm  
Min. base unit 300mm  
Cut out size 215 x 445mm  
Dimensions may vary plus or minus 2%



Berkshire – *Inset or undermounted*  
BERKSHIRE

W 450mm

**General features**

- White
- No tap facility
- 90mm waste outlet for a basket strainer waste
- Suitable for a waste disposer

**Plumbing options**

- Stainless steel waste and overflow CPK15
- Chrome waste and overflow CPK19
- Plumbing kit CPK1

**Fitting options**



Inset Undermounted

**Accessory options**



Wooden chopping board  
CBB3040B

**Dimensions**

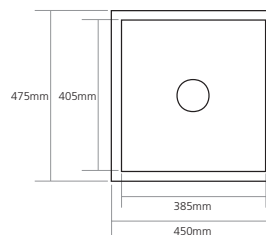

Bowl depth 180mm  
Overall sink depth 200mm  
Min. base unit 500mm  
Cut out size 420 x 440mm  
Dimensions may vary plus or minus 2%



**Warwickshire – Inset or undermounted**  
CPWIB2 W 460mm

**General features**

- White
- No tap facility
- 90mm waste outlet for a basket strainer waste
- Suitable for a waste disposer

**Plumbing options**

- Stainless steel waste and overflow CPK5
- Antique gold waste and overflow CPK16
- Plumbing kit CPK1

**Fitting options**



Inset Undermounted

**Accessory options**



Wooden chopping board  
CBB3040B

**Dimensions**

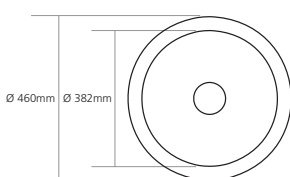

Bowl depth 166mm  
Overall sink depth 191mm  
Min. base unit 500mm  
Cut out size 435mm  
Dimensions may vary plus or minus 2%



**Cheshire – Inset**  
CPCIB2 W 595mm

**General features**

- White
- No tap facility
- 90mm waste outlet for a basket strainer waste
- Suitable for a waste disposer

**Plumbing options**

- Stainless steel waste and overflow CPK5
- Antique gold waste and overflow CPK16
- Plumbing kit CPK1

**Accessory options**



Wooden chopping board  
CBB3040B

**Dimensions**

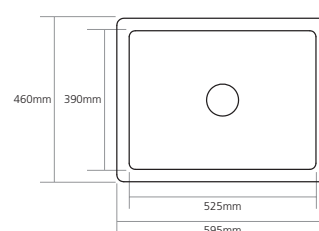

Bowl depth 227mm  
Overall sink depth 255mm  
Min. base unit 800mm  
Cut out size 575 x 440mm  
Dimensions may vary plus or minus 2%